

USER MANUAL

Installation, Maintenance and Operation
for
Electro Hydraulic Actuator
Type: KTC-PA..... und KTC-PA.....EX
„Part turn Actuator“

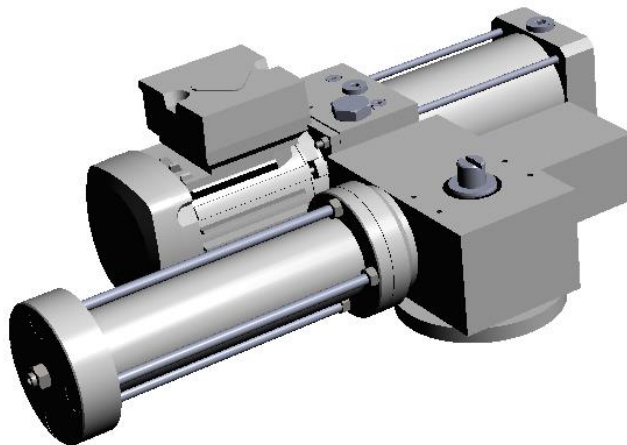

Actuators for Industrial Valves

Compact Power Pack

With integrated hydraulic power pack or, as actuator without power pack in order to be connected to external pressure supply

Safety position by spring return or accumulator solution (Fail Safe)

On/Off or Modulating

ATEX suitable Zone 1 and 2 (Type PA.....EX)

Operating Manual Installation Manual



Hydraulic Part Turn Actuator Typ: KTC-PA

Content

1	Safety Instructions.....	4
1.1	Basics.....	4
1.2	Concept of Warnings.....	4
1.3	Personal requirements.....	4
1.4	Intended use.....	5
1.4.1	Predictable misuse.....	5
2	Description of Application.....	5
3	Labelling.....	5
3.1	Identification number.....	6
3.2	CE marking.....	6
3.3	Additional marking.....	6
4	Transportation and storage.....	6
4.1	Storage.....	6
4.2	Long term storage.....	7
5	Installation.....	7
5.1	Installation in potential explosive areas.....	7
5.2	Mechanical connection onto valve.....	7
5.3	Adjustment of the rotating angle.....	8
5.4	Adjustment of the limitation of rotating angle.....	8
5.5	Hydraulic connection.....	8
5.6	Hydraulic System Precautions.....	8
5.7	Electrical Connection.....	9
5.8	Electric Precautions.....	9
5.8.1	Electric Motor Connection.....	9
5.8.2	How to verify correct motor turning direction.....	9
5.9	Checklist Commissioning / 1st start of actuator.....	9
6	Description of Actuator operation and control.....	9
6.1	General description of electro hydraulic actuator.....	9
	The actuator consist of hydraulic power pack (except type PA-HX for external hydraulic pressure supply), optional a valve block (solenoid valves, pressure sensor, accumulator, pressure relieve valves) and hydraulic ¼ turn hydraulic cylinder.....	9
6.2	On / Off Actuator.....	10
6.2.1	On/ Off Single Acting Spring Return/Fail Safe.....	10
6.2.2	On / Off Double Acting.....	10
6.3	Modulating Actuator.....	10
6.3.1	Fail Safe Function at modulating actuator.....	10
6.4	Manual Operation.....	10
6.5	Speed Adjustment.....	11
7	Spare Parts.....	11
8	Maintenance.....	11
8.1	Maintenance plan.....	11
8.2	Inspection of hydraulic oil level.....	12
8.3	Visual check of hydraulic oil.....	12
8.4	Oil change.....	12
8.5	Choice of Hydraulic Oil.....	12
8.6	Adjustment of pressure switches.....	12
8.7	Working on pressure system.....	12
8.8	Change of Spring.....	12
8.9	Adjustment of mechanical limits.....	13

Operating Manual Installation Manual



Electro Hydraulic Actuator Type: KTC-PA

8.10	Technical Problems	13
8.11	General instruction for maintenance	13
8.12	Maintenance works at KTC Actuator during guarantee period	13
9	Errors and malfunctions of actuator	14
10	Certificates and declaration of incorporation	14

1 Safety Instructions

1.1 Basics





From development to assembly of our KTC actuators, we are conform to international norms and directives. A confirmation according to directive 2006/95/EG is part of our delivery.

All personnel, working with this device must be familiar with the safety and warning instructions mentioned in this manual and observe the instructions given. Safety instructions and warning signs on the device must be observed to avoid personal injury or material damage.

1.2 Concept of Warnings

To avoid personnel injury and material damage, it is necessary to observe the indications mentioned in this manual.

Please see detailed table of indications below.

	Indicates an imminently hazardous situation with a high level of risk. Failure to observe this warning could result in death or serious injury.
	Indicates a potentially hazardous situation with a medium level of risk. Failure to observe this warning could result in death or serious injury.
	Indicates a potentially hazardous situation with a low level of risk. Failure to observe this warning may result in minor or moderate injury. May also be used with property damage.
	Potentially hazardous situation. Failure to observe this warning may result in property damage. Is not used for personal injury.

1.3 Personal requirements

Maintenance and user personal has to be qualified as follows:

- Skills and experience in hydraulic.
- Understanding of the complete system of the electro hydraulic actuator electrically and hydraulically as well as knowledge in reading schematic hydraulic and electric diagrams.
- Maintenance works on electric system and components by qualified staff only.

Electro Hydraulic Actuator Type: KTC-PA

1.4 Intended use

The Actuator shall be used for purposes as described in this manual only.

The Actuator is designed for use on industrial valves only.

The intended use includes the observance of this operating manual, as well as other relevant documents (schematic diagrams, additional manuals of components of actuator)

Utilization beside the described intended use, may induce critical situations and personnel injury or material damage.



Danger on incorrect use

Misuse of Actuators may induce personnel injury or material damage.

Please take care to avoid following miss use:

- Operation of Actuator beside the described intended use
- Operation of non Ex proof Actuators in potential explosive atmosphere. Please observe name late of actuator to check suitability.

1.4.1 Predictable misuse

Persons which are not conform to the requested requirements in knowledge and experience, are not allowed to use or work on the actuator. Also observe following misdemeanor

- Use of non-approved spare parts (please see applicable part list)
- Change of adjustment of pressure relieve valves
- Change of power supply voltage or signals
- Non-observance of operating manual and attendant documents.
- Non-observance of appropriate safety instructions
- Installation, operation, maintenance and repair of actuator of personnel without the requested technical competence.
- Removing or dis connection of safety equipment.

Any claims of personnel injury or material damages, due to incorrect use, are excluded.

The end user is responsible and liable for all damages, happen due to incorrect use.

2 Description of Application



The function of the actuator is to convert the output signal of an electronic regulator into a proportional, mechanical position. They may appear as relatively simple control operations but the practical experience makes great demands on the linearity, hysteresis, operating threshold and dynamic performance of the control units. The requirements are valid within a rather large temperature range – from arctic to tropical temperatures. The adaptation to the valve is a piston servo-motor (cylinder) with vertical working stroke.

The KTC Actuator is used for the adjustment of control and safety valves. High control precision, high control force and speed are the properties of KTC Actuators. The fields of application at electric power stations, chemical industry and pipelines.

3 Labelling

The name plate of every actuator as below.

Electro Hydraulic Actuator Type: KTC-PA

KTC Systemtechnik GmbH - Adlerhorst 3 - 22459 Hamburg	
Typ / Type:	PA x
Ident. No.:	10004-265/1
Bj. / Year:	2012
Anschluß / Connection:	400V 50Hz; 3 phs. / 24VDC
Pmax / max. pressure:	150bar
Spule /coil	U= 24V
 II 3G c k IIC	T4-20°C ≤ Ta ≤ 60°C
	

Tabel 1: sample of type and name plate of ex proof suitable actuator

3.1 Identification number

Every actuator is marked with its own identification number.

3.2 CE marking

The KTC actuators are (according to the European directive 2006/42/EG) an incomplete machine. In this case, a CE marking is prohibited.

Except for actuators, suitable for use in potentially explosive atmosphere. For those actuators, the CE marking is mandatory.

3.3 Additional marking

According to customer requirements, additional markings on the actuator are possible.

4 Transportation and storage

KTC Actuators are packed according to transportation requirements. Please unpack and repack with care.

DANGER

- Never stay under hovering weights.
- Never raise the actuator on its lifting points together adapted valve.
- Use correct and soft belts only.
- Do not fix the belts on actuator components

4.1 Storage

To avoid material damage, please follow the recommended list below.

NOTICE

- The actuator shall be clean and dry prior to placement in storage
- Protect the actuator against humidity, high or low temperature dust and dirt.
- Protect the actuator of mechanical damages.

Electro Hydraulic Actuator Type: KTC-PA

4.2 Long term storage

For storage above the period of 6 months, the coupling parts, screws and nuts as well as non-varnished parts of actuator shall be protected with suitable, non-corrosive grease.

Please check the conditions of the actuator and its protection every 6 months. We recommend to operate the actuator, full open and full close several times.

5 Installation

Installation shall be carried out as described in this manual. This manual does not cover all KTC electro hydraulic actuators in detail, always refer to the job specific documents also. These documents are always indicated with a project number which is also mentioned on actuator name plate.

Installation works shall be carried out by experienced persons only.

It is recommended, before installation, to read the job specific hydraulic and electric diagrams. Please observe the job specific control requirements.

5.1 Installation in potential explosive areas



Please read following instruction before installation in potential explosive areas.

- Only experts and experienced personnel shall be in charge with the installation of an actuator.
- The actuator must be suitable for potential explosive areas. Please check type plate.
- Temperature range and gas group has to be in accordance with the conditions on site.
- The job specific control devices (if applicable: motor control, temperature- and pressure control, limit switches) are connected and in function.
- Please make sure the proper grounding of the actuator.

5.2 Mechanical connection onto valve.

Check both sides, actuator and valve flange dimension, before lifting onto valve.



Carefully connect the actuator onto valve, it may a risk of injury.

If an adjustment of the piston necessary, please use hand pump if exist.

Make sure, that after installation onto valve, there is no risk of injury from moving parts. Protect with solid mechanical provision.

- Pay attention to correct position of actuator onto valve (open and close)
- Raising of actuator at defined positions only. Never raise valve via actuator.
- Watch correct position of piston rod.
- Make sure that the flange is clean.
- Use non corrosive grease at mechanical parts (flange, screws, rod, threat) as antirust protection.
- Pay attention to correct torque of screws
- If possible, start with a manual test of actuator after mounting onto valve.

Electro Hydraulic Actuator Type: KTC-PA

5.3 Adjustment of the rotating angle

Usually, the angle adjustment is factory made. A change of the angle is possible with modulating actuators only. Please keep in mind to re-adjust position transmitter accordingly. Please contact KTC Systemtechnik for further queries.

5.4 Adjustment of the limitation of rotating angle

The actuators are equipped with mechanical limit stops to adjust the end positions (opening and closing).

Tools: Allen key, open-ended spanner (size different, depending on actuator size), cleaning rag.

While the adjustment of the limit stops, oil will come out of the thread of stop screw.

Procedure to adjust the limit stops:

- Make sure that the actuator is not in end position to avoid direct contact to stop screw.
- Remove cap nut (make sure that the check nut will not move)
- Loose the check nut while keep the stop screw in position.
- Execute the adjustment.
- Tighten the check nut again and check limit stop by moving the actuator
- Repeat this procedure until the desired angle is obtained.
- Mount the cap nut while keeping the check nut in position.
- Check limit stops for oil leakage. Change cu-ring if necessary.
- Check oil level and refill if necessary.

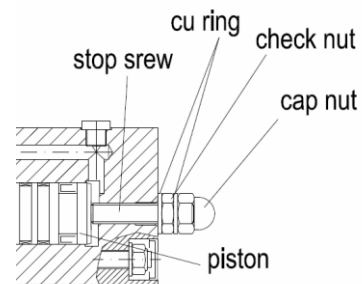

WARNING

Make sure there is no oil leakage after adjustment.

5.5 Hydraulic connection

We recommend that, any hydraulic tube works in case of external hydraulic pressure supply, or in case of separate location of power pack and cylinder, shall be carried out by experienced persons only. Locally safety instructions shall be observed.

5.6 Hydraulic System Precautions

WARNING

- Release hydraulic pressure before working on hydraulic system.
- Always wear appropriate safety clothing and safety glasses
- Read hydraulic schematic diagrams of actuator or hydraulic system.
- Read hydraulic oil safety instructions
- Tighten the hydraulic connections to avoid leakage

DANGER

- If hydraulic oil is pressurized, it can pierce the skin and may go into blood stream.

Electro Hydraulic Actuator Type: KTC-PA

5.7 Electrical Connection

Always refer to actuator specific wiring diagram which is part of the actuators documentation. The electrical connection shall be executed by professionals only. Locally safety instructions and standards of practice shall be observed. Make sure that power supply is switched off and protect against accidental activation while connection works.



Incorrect connection may cause injury or damage.

5.8 Electric Precautions

- Never work on electric system while the actuator is under voltage
- Always refer to KTC job specific electric diagram
- Observe voltage and current limits
- Ensure the correct distance between signal cable and power cable.
- Close all cable glands which are not in use

5.8.1 Electric Motor Connection

Ensure that the power supply correspond with data at motor type plate. Verify the correct turning direction of the electric motor to avoid damages on hydraulic system. The correct turning direction is marked on motor housing (arrow).

5.8.2 How to verify correct motor turning direction

You can see the motor air cooling fan, verify with marking (arrow)
You can observe pressure gauge. After few seconds, the pressure shall rise.

- In case of bi-directional motor and hydraulic pump, there is no danger of damage.

5.9 Checklist Commissioning / 1st start of actuator

Please ensure the following list can be confirmed:

- No persons stay in area of risk.
- A steady position of actuator. Due to high force the actuator masses may move.
- Correct electrical connection according to KTC wiring diagram.
- Correct hydraulic connection according to KTC hydraulic schematic.
- Correct hydraulic oil filling (see section 10.2).
- Correct position of actuator and valve.
- Control and safety functions by external process control are realized (i.e. motor stop at limit switch "open" or at pmax switch etc.). Read the job specific actuator description with logic table.

6 Description of Actuator operation and control

Always refer to job specific actuator description.

6.1 General description of electro hydraulic actuator

The actuator consist of hydraulic power pack (except type PA-HX for external hydraulic pressure supply), optional a valve block (solenoid valves, pressure sensor, accumulator, pressure relieve valves) and hydraulic ¼ turn hydraulic cylinder.

Electro Hydraulic Actuator Type: KTC-PA

The runtime of electric motor and the pressure of hydraulic system shall be under automatic control always. Optional the actuator is equipped with oil temperature and oil level switches. Please observe the job specific description, wiring diagram and hydraulic schematic.

6.2 On / Off Actuator

The on/off duty actuator is made for valves with two positions only (open / close). On/off actuator with more than two positions also available on request.

6.2.1 On/ Off Single Acting Spring Return/Fail Safe

A running electric motor makes the hydraulic system pressure rising until, in the pressure relieve valve adjusted pressure (pmax) has reached. The pressure moves the cylinder piston rod, against the spring force, towards open or close position of the valve. The piston remains in this position until the solenoid valve is deactivated and release the pressure from cylinder to oil container. The spring will move the piston in its opposite position.

6.2.2 On / Off Double Acting

These actuators are equipped with a reversing electrical motor. The motor management (on/off/ left/right, runtime) shall be executed by process control. A separate control box can be part of delivery. Please see order related wiring diagram.

6.3 Modulating Actuator

The modulating duty actuator is developed for control valves.

A analog control signal, created by the process control, determine the position of the control valve (i.e. 4mA = 0% ; 20mA = 100%). The 4-20mA signal is received by the electronic position controller, will be amplified and send to the proportional control valve. A feedback position transmitter, also connected to the position controller, closes the loop.

Usually, our modulating actuators always equipped with pressure accumulator to store the hydraulic system pressure. The electric motor operates until the hydraulic pressure "pmax" has reached, and it will start again after low pressure switch "pmin" gives a signal. Internal or external motor management has to be realized. Please see order related wiring diagram

6.3.1 Fail Safe Function at modulating actuator

Also modulating actuators are available with fail safe function (fail open/fail close). There are both possible to realize fail safe function, spring return or pressure accumulator. Similar to the on/off actuator, we use a solenoid valve to, either release the pressure from cylinder chamber that makes the spring expanding, or, release the system pressure from accumulator into a cylinder chamber and release the opposite chamber to oil container.

6.4 Manual Operation

Actuators might be able for manual operation in case of power failure. Every actuator can be ordered incl. manual hand pump.

If the actuator is not equipped with hand pump, we supply a special hydraulic connection in order to connect an external hand pump (see hydraulic schematic).

An electrical manual operation is also available on request.

In this case, there are a local/remote switch and UP and DOWN push buttons.



Make sure there is no person in area of risk while operating manually.

Operating Manual Installation Manual



Electro Hydraulic Actuator Type: KTC-PA

6.5 Speed Adjustment

Optional

The travelling speed for modulating and/or fails safe function is adjustable on request. Depending on requirements we equip the actuator with throttle valves for manual adjustment. Control speed may be adjusted by controller software. Please see hydraulic schematic for throttle valves and electrical manuals of position controller.



The throttle valve, in case of closing, it may set the fail safe function and/or modulating function out of order.

7 Spare Parts

In case of spare parts requirements, please observe part list and supply the identification number of the actuator.

Please note: Utilize only original KTC spare parts

8 Maintenance

8.1 Maintenance plan

Inspection	Recommendation	
	Modulating Actuator	On/Off Actuator
Change Oil	After 2 years of operation	After 4 years of operation
Visually check leakage	1x/Month	1x/Month
Visually check oil level	1x/Month	1x/Month
Visually check oil conditions	1x/ half-year	1x/ half-year
Stroke test fail safe function	According to operators estimation, min 1x/Year	
Bladder-pressure control accumulator	1x /Year	1x /Year
Exchange of flexible hydraulic tube	6 years	
Check for unusual sounds	1x/Month	

Electro Hydraulic Actuator Type: KTC-PA

8.2 Inspection of hydraulic oil level

According to actuator type please check oil level as follows

- Oil sight glass: always fully covered
- Oil dip stick: oil level between min and max marking.
- Visual check by opening the oil filling screw. Oil level shall be about 10mm below screw.

8.3 Visual check of hydraulic oil

The hydraulic oil should be clear and transparent. The tank bottom should be free of impurities.

Whitish discoloration indicates water in the oil.

Dark discoloration indicates oil wear.

8.4 Oil change

Release oil drain plug, or use an oil suction device.

Please make a visual check of the hydraulic oil. In case of pollution, disassemble the oil container and clean it separately.

Refill up to 10mm lower than top edge of oil tank.

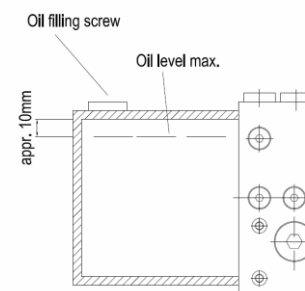

8.5 Choice of Hydraulic Oil

Use hydraulic oil according to DIN 51524-2 and/or DIN ISO 15380:2012-03, for biodegradable oils. The viscosity shall be at 32 to 46mm²/s at 40°C .

For modulating actuators, please use pre-filtered hydraulic oil only.

- Modulating actuators Control-Valves NG6: pre filtration 10,0µm
- Modulating actuators Control-Valves NG3: pre filtration 3,0µm
- On/Off Actuators: pre filtration 10,0µm

8.6 Adjustment of pressure switches.

Please refer to user manual of specific pressure switch.

8.7 Working on pressure system

Before working on pressure system release pressure! Make sure a pressure gauge is connected to pressure circuit.



Only qualified persons with experience in hydraulic systems shall perform any works on hydraulic pressure system.

Disregard of this instruction may cause bodily injury.

- Cut off the Actuator from power supply and prevent an accidental start
- For actuators with pressure accumulator:
Release system pressure and accumulator pressure with the pressure relief valve (covered with black plastic cap) by using a spanner (size 17mm)
Open the valve until the system pressure is zero
The pressure gauge shows the system pressure.

8.8 Change of Spring

Valid for spring return actuators only.



Electro Hydraulic Actuator Type: KTC-PA

WARNING

Spring under heavy preload!

Follow the instruction below to avoid personal injury or material damage.

- Assembly and dis-assembly instructions are supplied with every spring return actuator.
- Qualified staff only shall perform work on spring only.
- Opening of spring housing only in non-pressurized and spring released situation.

8.9 Adjustment of mechanical limits

The quarter turn actuators are equipped with mechanical limits.

8.10 Technical Problems

Please contact KTC Systemtechnik in case of uncertainties and technical problems to avoid material damage.

8.11 General instruction for maintenance

KTC Systemtechnik recommend to consult qualified staff for any maintenance work at KTC Actuators only.

WARNING

- Before start working on hydraulic system, the oil pressure of the actuator has to be released completely. Please observe pressure gauge.
- Protect the actuator for unintended activation.
- Before opening of case of spring refer to related KTC instructions. The spring has to be in released position. Please note that the spring is preloaded.
- Non-observance of above instructions may lead to injuries.

8.12 Maintenance works at KTC Actuator during guarantee period

In case of needful maintenance work at KTC actuators during the period of guarantee, please contact and inform KTC Systemtechnik in advance. The guarantee period may end or set out.

Electro Hydraulic Actuator Type: KTC-PA

9 Errors and malfunctions of actuator

Pos	Error description	Possible reasons	Solving the problem
1	No movement at all, now pressure at pressure gauge	<ul style="list-style-type: none"> - Fail Safe Valve or bypass valve open - Motor protection activated - Motor fault - Hydraulic oil level low - Pressure switch fault - Hydraulic oil polluted 	<ul style="list-style-type: none"> - Observe main switch - Close fail safe valves - Activate motor protection - Motor check - Check Oil level, refill if necessary. - Visual check of oil leakage - Check pressure switch - Change oil, clean oil container,
2	No movement, system pressure available	<ul style="list-style-type: none"> - Fail safe activated - 24 VDC supply interrupted - Electronic controller fault - Control signal in/out interrupted - Mechanic problem at piston or valve 	<ul style="list-style-type: none"> - Check reason for fail safe - Activate 24VDC supply - Check controller - Check wiring - Mechanical check
3	Motor does not stop after arriving max. pressure	<ul style="list-style-type: none"> - Pressure switch fault - Elektrical fault (relay) - Control software mistake 	<ul style="list-style-type: none"> - Check Pressure switch - Check wiring - Check control software
4	Motor does not switch of after arriving limit switch	<ul style="list-style-type: none"> - Limit switch fault - Elektrical fault (relay) - Control software mistake 	<ul style="list-style-type: none"> - Check limit switch - Check wiring - Check control software
5	Error of positioner	<ul style="list-style-type: none"> - Input signal missing - Position feedback signal missing - Missing connection to solenoid valve 	Check signals and wiring
6	Oil leakage	<ul style="list-style-type: none"> - Loose stop screw - Loose oil filling screw - Loose oil release screw - Defect sealing 	<ul style="list-style-type: none"> - Tighten srew - Check sealing - Change sealing - Change cu-ring

NOTICE

To be able to understand errors and it's patching it is essential to read and understand this operating manual, relating manuals of components from sub-supplier as well as hydraulic schematic and wiring diagram.

In case of any doubts and queries please contact KTC Systemtechnik.

10 Certificates and declaration of incorporation

According to the European directive 2006/42/EG, Actuators for valves are incomplete machines. Part of the documentation of any KTC Actuator is the declaration of incorporation. A CE marking for incomplete machines are prohibited.

All Actuators suitable for installation and operation in potentially explosive atmosphere are in conformance to the European directive 94/9/EG. Part of documentation is the relevant declaration of conformity.

These actuators are CE marked.

Operating Manual Installation Manual



Electro Hydraulic Actuator Type: KTC-PA

KTC Systemtechnik GmbH

Krähenweg 11

22459 Hamburg

Tel.: 040/5714 752-0

Fax: 040/5714 752-22

Email: info@ktc-systemtechnik.de

www.ktc-systemtechnik.de